



Australian Government
**National Measurement
Institute**

Bradfield Road, West Lindfield NSW 2070

Notification of Change
Certificate of Approval No 10/1/20
Change No 2

Issued by the Chief Metrologist under Regulation 60
of the
National Measurement Regulations 1999

The following changes are made to the approval documentation for the
Batchen Model C2000-DCE-PA LPG Fuel Dispenser for Motor Vehicles

submitted by D J Batchen Pty Ltd
 2-6 Raglan Road
 Auburn NSW 2144.

- A. In Certificate of Approval No 10/1/20 dated 22 August 2007, the FILING
 ADVICE should be amended by adding the following:

“Notification of Change No 2 dated 10 March 2010”

- B. In Technical Schedule No 10/1/20 dated 10 December 2001, clause
 1.1 Field of Operation should be amended, in part, as follows:

“LPG density detection range 500 kg/m³ to 590 kg/m³ (at 15°C)”

Signed by a person authorised by the Chief Metrologist
to exercise his powers under Regulation 60 of the
National Measurement Regulations 1999.

A handwritten signature in black ink, consisting of a series of loops and flourishes, positioned above a horizontal line.



Australian Government

**National Measurement
Institute**

Bradfield Road, West Lindfield NSW 2070

Certificate of Approval

No 10/1/20

Issued by the Chief Metrologist under Regulation 60
of the
National Measurement Regulations 1999

This is to certify that an approval for use for trade has been granted in respect of the

Batchen Model C2000-DCE-PA LPG Fuel Dispenser for Motor Vehicles

submitted by D J Batchen Pty Ltd
 2-6 Raglan Road
 Auburn NSW 2144.

NOTE: This Certificate relates to the suitability of the pattern of the instrument for use for trade only in respect of its metrological characteristics. This Certificate does not constitute or imply any guarantee of compliance by the manufacturer or any other person with any requirements regarding safety.

This approval has been granted with reference to document NMI R 117-1, *Measuring Systems for Liquids Other than Water*, dated July 2004.

CONDITIONS OF APPROVAL

This approval becomes subject to review on 1 September 2012, and then every 5 years thereafter.

Instruments purporting to comply with this approval shall be marked with approval number 'NSC 10/1/20' and only by persons authorised by the submittor.

Instruments purporting to comply with this approval and currently marked with approval number 'NSC P10/1/20' should be re-marked NSC No 10/1/20 and only by persons authorised by the submittor.

It is the submitter's responsibility to ensure that all instruments marked with this approval number are constructed as described in the documentation lodged with the National Measurement Institute (NMI) and with the relevant Certificate of Approval and Technical Schedule. Failure to comply with this Condition may attract penalties under Section 19B of the National Measurement Act and may result in cancellation or withdrawal of the approval, in accordance with document NMI P 106.

The National Measurement Institute reserves the right to examine any instrument or component of an instrument purporting to comply with this approval.

Auxiliary devices used with this instrument shall comply with the requirements of General Supplementary Certificate No S1/0/A.

DESCRIPTIVE ADVICE

Pattern: provisionally approved 14 August 2001
approved 29 October 2001

- A Batchen model C2000-DCE-PA attendant-operated fuel dispenser for refuelling motor vehicles using liquefied petroleum gas (LPG). The model number may be without the 'PA' suffix.

Variant: provisionally approved 14 August 2001
approved 29 October 2001

1. Certain other models and configurations.

Variant: approved 6 December 2001

2. With a magnetic coupling between the meter and the pulse generator.

Technical Schedule No 10/1/20 describes the pattern and variants 1 & 2.

Variant: approved 27 June 2002

3. Models C11-SEE-PA and C11-DEE-PA.

Technical Schedule No 10/1/20 Variation No 1 describes variant 3.

Variant: approved 21 August 2007

4. With a Transponder Technologies model T5 calculator/indicator.

Technical Schedule No 10/1/20 Variation No 2 describes variant 4.

FILING ADVICE

Certificate of Approval No 10/1/20 dated 16 September 2002 is superseded by this Certificate, and may be destroyed. The documentation for this approval now comprises:

Certificate of Approval No 10/1/20 dated 22 August 2007
Technical Schedule No 10/1/20 dated 10 December 2001 (incl. Test Procedure)
Technical Schedule No 10/1/20 Variation No 1 dated 16 September 2002
Technical Schedule No 10/1/20 Variation No 2 dated 22 August 2007 (incl. Notification of Change)
Notification of Change No 1 dated 11 January 2002
Figures 1 to 14 dated 10 December 2001
Figures 15 and 16 dated 16 September 2002



Signed by a person authorised by the Chief Metrologist to exercise his powers under Regulation 60 of the *National Measurement Regulations 1999*.

A handwritten signature in black ink, consisting of a large, stylized 'J' followed by a horizontal line and a vertical stroke.

TECHNICAL SCHEDULE No 10/1/20

Pattern: Batchen Model C2000-DCE-PA LPG Fuel Dispenser for Motor Vehicles

Submittor: D J Batchen Pty Ltd
2-6 Raglan Road
Auburn NSW 2144

1. Description of Pattern

The Batchen model C2000-DCE-PA is an attendant-operated fuel dispenser for refuelling motor vehicles using liquefied petroleum gas (LPG).

The model C2000-DCE-PA dual (twin) LPG dispenser (Figures 1 and 2) includes the following components or features:

- A Batchen model Mk-V constant bleed vapour elimination device.
- Two Batchen model Mk III LPG liquefied petroleum gas (LPG) flowmeters each fitted with an Email Electronics model VN pulse generator.
- Two Batchen model Mk VI spring-loaded pressure differential valves.
- A calculator/indicator configured for use with a density detection device enabling the volume conversion to 15°C.
- An optional pre-setting device.

1.1 Field of Operation

The field of operation of the measuring system is determined by the following characteristics:

- Minimum measured quantity, V_{min} 2 L
- Maximum flow rate, Q_{max} 60 L/min
- Minimum flow rate, Q_{min} 10 L/min
- Ambient temperature range -25°C to 55°C
- LPG density detection range 505 kg/m³ to 570 kg/m³ (at 15°C)
- Volume conversion to 15°C over a liquid temperature range of -10°C to 45°C
- Operating pressure is maintained at least 200 kPa above the equilibrium vapour pressure of LPG.

1.2 System Description

- (i) The supply tank may be located above or below ground.
- (ii) The pump may be positioned above the supply tank, in which case the pump shall be a multi-stage regenerative turbine LPG pump especially designed for use in **suction lift** installations. Alternatively, the pump shall be positioned below the supply tank so that it is always in a state of flooded suction (**suction head** installations). There are no restrictive fittings within ten pipe diameters of the pump inlet.

The inlet pipe to the pump is larger than the outlet from the pump. The external pump by-pass relief valve is installed in a line returning to the vapour space of the supply tank.

A pump supplying LPG to several flowmeters shall be of sufficient capacity rating to ensure that when all flowmeters are in use the flow rate through each flowmeter is greater than Q_{min} .

- (iii) A Batchen constant bleed vapour eliminator with an integral strainer (Figures 3 and 4) positioned upstream of each flowmeter, in conjunction with a pressure differential valve downstream of each flowmeter, protect the flowmeters from the measurement of vapour. The thermometer well for checking the temperature measurement of LPG is situated in the top of the vapour eliminator.
- (iv) Two Batchen model Mk III two-piston LPG flowmeters are used (Figure 5) each fitted with a Email Electronics model VN pulse generator with an output of 100 pulses per revolution.
- (v) A Batchen model Mk VI spring-loaded pressure differential valve is fitted to the flowmeter outlet. A pressure-equalising pipe is connected from the top of the differential valve to the vapour space of the supply tank. The differential valve may be fitted with one or more bleed valves. In normal operation, the bleed valves are sealed with caps to prevent leakage.
- (vi) A Batchen hydraulic accumulator may be fitted downstream of the pressure differential valve.
- (vii) A 1/2" NPT flow solenoid valve is located downstream of the pressure differential valve. The solenoid valve controls the delivery and prevents delivery during the reset cycle. If a pre-setting device is fitted, the system will also include a 1/4" NPT flow solenoid valve (Figure 6).
- (viii) The fuel dispenser is fitted with hoses of 15 or 20 mm nominal bore and incorporating a Batchen model Sentry 20 hose beak-away coupling fitted between the the flow solenoid valve and the nozzle.

The nozzles used are either Gasguard model LG1DNS or any other compatible Commission-approved LPG nozzle, suitable for the hang-up mechanism.

- (ix) The calculator/indicator (Figure 7) comprises an Email model Vision computing board and two Email model Vision display boards. The indicators display the following maximum values:

Volume	999.99 L in 0.01 L increments
Unit price	999.9 c/L in 0.1 cent increments
Total price	\$999.99 in 1 cent increments
Totaliser (volume)	99999 L in 1 L increments
Pre-set (optional)	\$999 in \$1 increments

The calculator/indicator can display LPG density at 15°C used for conversion of volume to 15°C, and can display the temperature of LPG flowing through the meter (refer Test Procedure).

The main software version number for the calculator/indicator is B4.### which may be viewed using the 'test' button (refer to the Test Procedure).

1.3 Operation

Removal of the nozzle from its hang-up starts the operating cycle. The display will be cleared of any previous sale and the remote pump will start. The system electronics will automatically check for pulse generator rotation and correct electronic parameters.

A segment check is initiated; when completed the unit price is displayed and the price and volume displays show all zeroes. At the end of this cycle, the flow solenoid valve opens allowing a delivery to commence. Replacing the nozzle to its normal hang-up position closes the solenoid valve. The delivery details are displayed until the next reset cycle.

1.4 Volume Conversion Device

The electronic volume conversion for temperature facility is used to convert the measured volume to volume at 15°C using the volume conversion factors as a function of density in accordance with Table 54 of the ASTM-IP-API Petroleum Measurement Tables for Light Hydrocarbon Liquids.

The calculator/indicator is configured for use with an LPG Measurement model DSS*-98 (*) density detector probe to display the delivered volume at 15°C.

(*) DSS*-98 where * is either B or P, depending on type of connection.

1.5 Markings

Instruments are marked with the following data, together in one location on a data plate:

Pattern approval sign	NSC No 10/1/20
Manufacturer's identification mark or trade mark
Manufacturer's designation (model number)
Serial number
Year of manufacture
Maximum flow rate (Q_{max}) L/min
Minimum flow rate (Q_{min}) L/min
Minimum measured quantity (V_{min}) L (#)
Maximum operating pressure (P_{max})	2450 kPa
Minimum pressure (P_{min})	200 kPa above vapour pressure (♦)
Approved for LPG density range	505 kg/m ³ to 570 kg/m ³ (at 15°C)
Maximum liquid temperature (T_{max})	... °C
Minimum liquid temperature (T_{min})	... °C
Accuracy class	class 1.0
Environmental class	class C

(#) The minimum measured quantity shall be clearly visible on any indicating device visible to the user during measurement.

(♦) Alternatively, the following wording may be used:

“LPG pressure (at the meter) is maintained at least 200 kPa above vapour pressure.”

Note: The words “at the meter” may be deleted to save space.

1.6 Recirculation Line

A recirculation line with a double check filler valve is provided at the dispenser for returning the LPG back to the supply tank. The recirculation line is used for maintenance checking or calibration of the dispenser.

1.7 Sealing and Verification/Certification Provision

Provision is made for the application of a verification/certification mark on the fuel dispenser.

A plate covering the calibration switch situated inside the calculator/indicator, and the mechanical calibration device on the flowmeter, have provision for sealing.

2. Description of Variants

2.1 Variant 1

Certain models of the C2000 ('Concept 2000') series or CII ('Commander II') series as identified below:

- As CII ('Commander II') series dispensers (Figure 8) which have the same features and metrological specifications as the pattern, in which case the pattern (model C2000-DCE-PA) becomes a model **CII**-DCE-PA.
- As single (one hose) dispensers (Figure 8), in which case the pattern becomes a model C2000-**SCE**-PA.
- As quad (four hose) dispensers (Figure 9), in which case the pattern becomes a model C2000-**QCE**-PA.
- With alternative housing styles, e.g. 'Wardrobe' (rectangular) style (Figure 8), in which case the pattern becomes a model C2000-**DWE**-PA. Other housing styles (and their codes) are 'twin column' (T) (Figure 10), 'MPP' (M) (Figure 11), 'end oriented' (J) (Figure 12), and 'handed twin' (H) (Figure 13).
- With lower (non-metrological) specification levels, namely 'Standard', in which case the pattern becomes a model C2000-DCE-**SA**. Refer to the optional items marked in Figure 2.



2.2 Variant 2

With a magnetic coupling between the meter and the pulse generator (Figure 14).

TEST PROCEDURE

Maximum Permissible Errors at Verification/Certification

The maximum permissible errors applied during a verification test of the fuel dispenser using the liquid for which it is to be verified/certified, and from normal flow rate to the minimum flow rate specified in the Certificate of Approval or Technical Schedule are:

- ±0.6% for the calibration/adjustment of the meter; and
- ±1.0% for inservice inspection of the complete measuring system.

Other applicable maximum permissible errors are:

- ±0.5°C for the temperature measuring device;
- ±10 kg/m³ for the density detection device;
- ±0.4% for the volume conversion for temperature device;
- ±2.0% for deliveries equal to the minimum measured quantity; and
- ±1.0% for gas elimination for LPG.

Calibration Procedure

For detailed configuration and code setting procedures, refer to the manufacturer's service manual.

The calibration of the flowmeter shall be carried out using the unconverted volume.

To view temperature, density and unconverted volume on the calculator/indicator:

1. Turn the manager's key 90°. Dashes ("-----") will appear on the display.
2. There are four buttons marked by dots, broken lines or pre-set keypad, situated on the front or rear of the indicator/calculator.
3. The buttons from left to right are:
 - test button
 - manager digit change
 - down
 - up
5. Press the 'test' button to view unconverted volume. Keep pressing to view temperature, density and software version number (B4.###). Note that the displayed LPG density is at 15°C.

To perform a unit price change

1. Turn the manager's key 90°. Dashes ("-----") will appear on the display.
2. Press the 'test' button until "Set Price" is displayed by the indicator.
3. Lift a nozzle and a small digit will appear on the indication - this correlates to the digit being changed, and pressing 'manager/digit change' button can change this digit.
4. Press the 'up' or 'down' button to change each digit of the unit price.

10/1/20
16 September 2002

TECHNICAL SCHEDULE No 10/1/20
VARIATION No 1

Pattern: Batchen Model C2000-DCE-PA LPG Fuel Dispenser for Motor Vehicles

Submittor: D J Batchen Pty Ltd
2-6 Raglan Road
Auburn NSW 2144

1. Description of Variant 3

The Batchen model C11-SEE-PA (single) and model C11-DEE-PA dual (twin) LPG fuel dispensers which are similar to the pattern but in alternative housing styles as shown in Figures 15 and 16, respectively.

TECHNICAL SCHEDULE No 10/1/20

VARIATION No 2

Pattern: Batchen Model C2000-DCE-PA LPG Fuel Dispenser for Motor Vehicles

Submitter: D J Batchen Pty Ltd
2-6 Raglan Road
Auburn NSW 2144

1. Description of Variant 4

With the calculator/indicator described for the pattern replaced by a Transponder Technologies model T5 calculator/indicator (as described in the documentation of approval NSC S414).

The model T5 calculator/indicator is configured for use with a density detection device enabling volume correction for temperature to 15°C.

NOTIFICATION OF CHANGE

1. In Certificate of Approval No 10/1/20 dated 10 December 2001, the Condition of Approval referring to the review of the approval has been amended to read:

‘This approval becomes subject to review on 1 September **2012**, and then every 5 years thereafter.’

2. In Technical Schedule No 10/1/20 dated 10 December 2001, clauses **1. Description of Pattern** and **2.1 Variant 1** should be amended by adding the following as the last paragraph:

‘The model number of the pattern or variants may be without the ‘PA’ or ‘SA’ suffix, e.g. the pattern (model C2000-DCE-PA) may also be known as the model C2000-DCE”.

10/1/20
11 January 2002

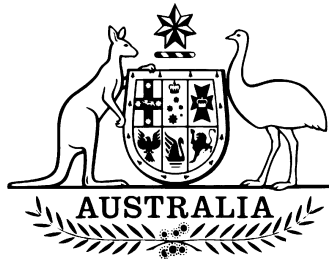

National Standards Commission

12 Lyonpark Road, North Ryde NSW

Notification of Change

Certificate of Approval No 10/1/20

Change No 1

The following change is made to the approval documentation for the

Batchen Model C2000-DCE-PA LPG Fuel Dispenser for Motor Vehicles

submitted by D J Batchen Pty Ltd
2-6 Raglan Road
Auburn NSW 2144.

In Technical Schedule No 10/1/20 dated 10 December 2001, clause 1. **Description of Pattern** should be amended by adding the following as the last paragraph:

“Instruments may be used for self-serve arrangements when connected to a compatible Commission-approved control console.”

Signed by a person authorised under Regulation 60 of the National Measurement Regulations 1999 to exercise the powers and functions of the Commission under this Regulation.



10/1/20
10 December 2001

FIGURE 10/1/20 - 1



Batchen Model C2000-DCE-PA LPG Fuel Dispenser for Motor Vehicles

10/1/20
10 December 2001

FIGURE 10/1/20 - 2

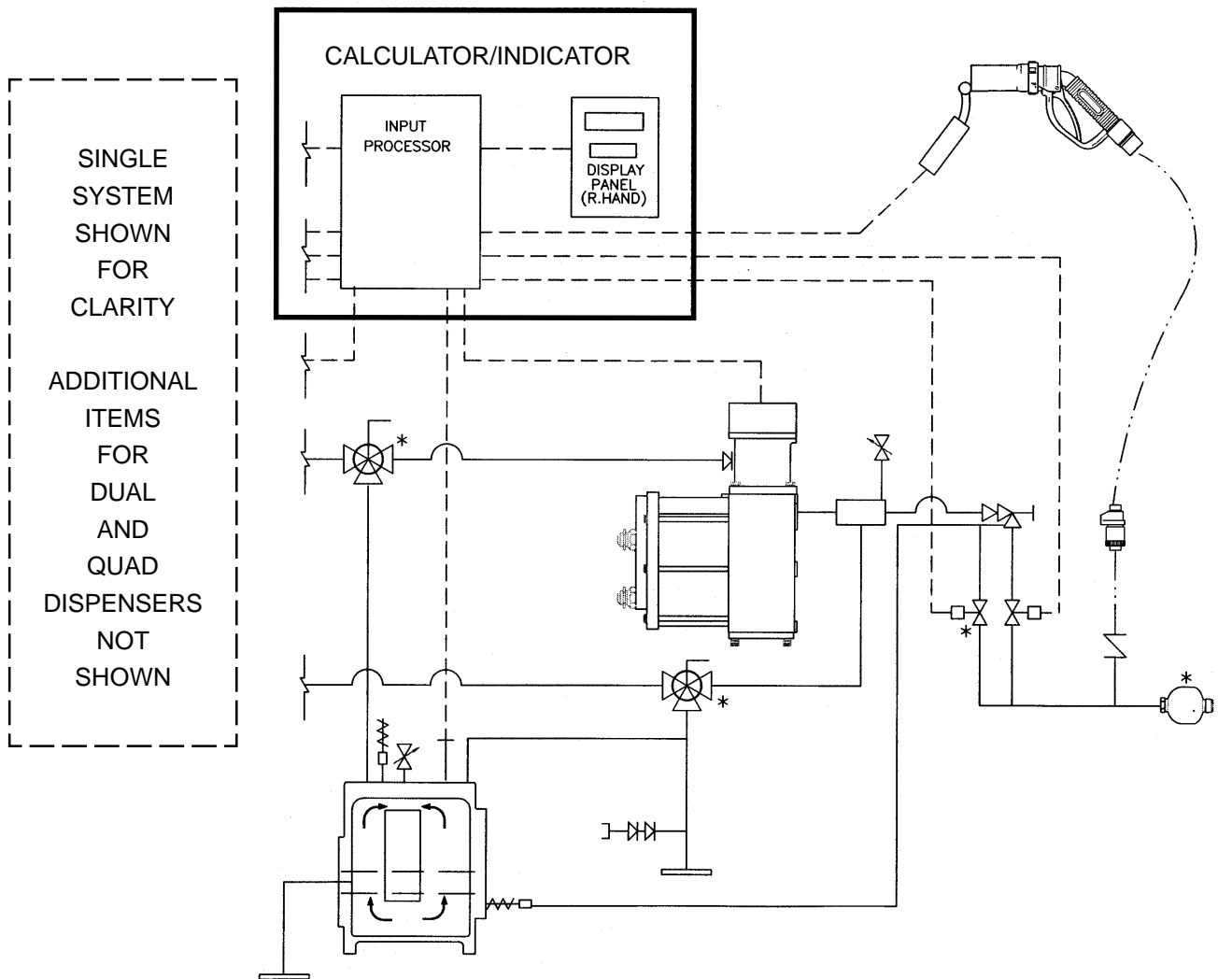

Batchen Model C2000-DCE-PA LPG Fuel Dispenser — Single System Shown for Clarity

FIGURE 10/1/20 - 3



Batchen Vapour Eliminator

10/1/20
10 December 2001

FIGURE 10/1/20 - 4

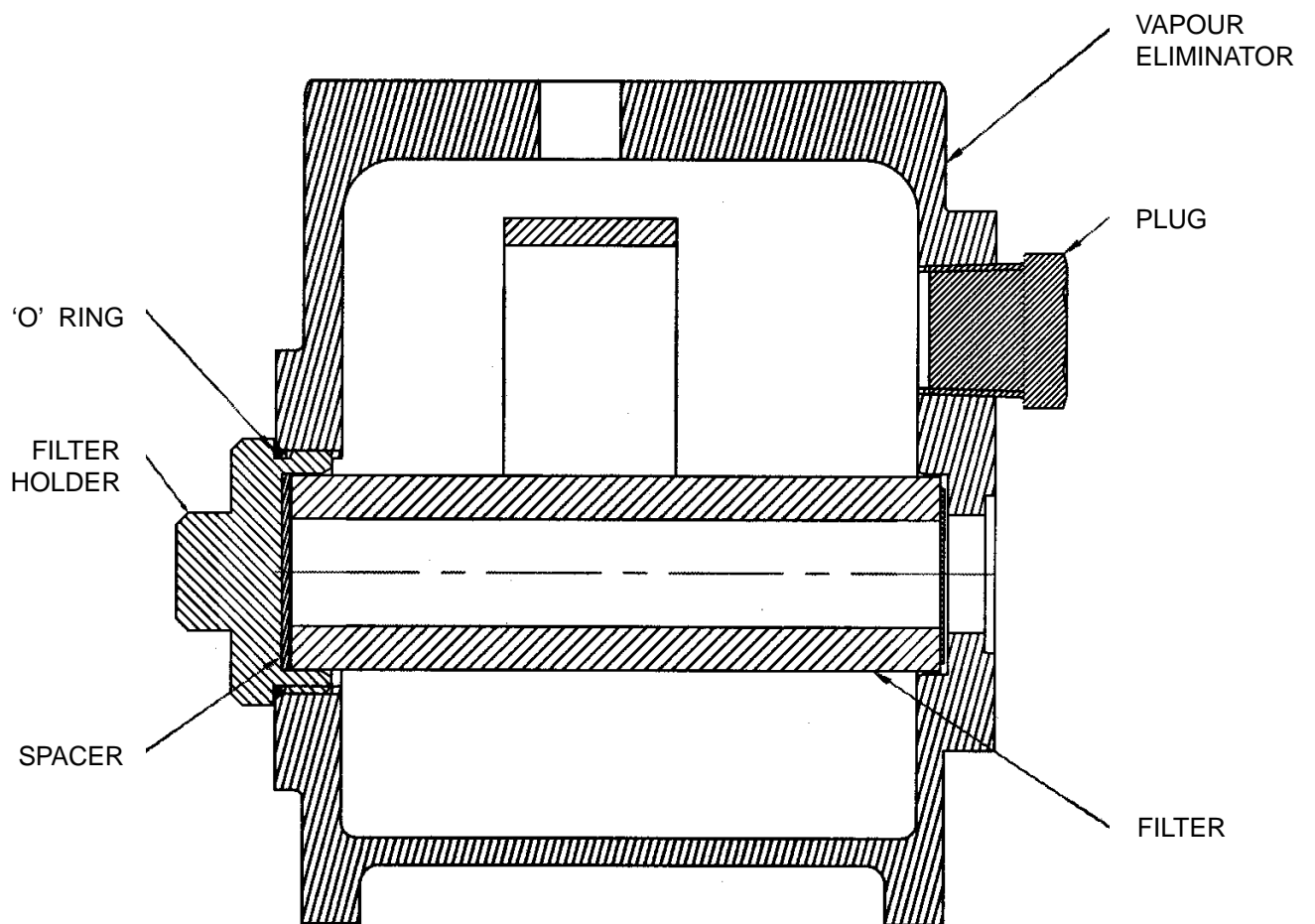

Batchen Vapour Eliminator

10/1/20
10 December 2001

FIGURE 10/1/20 - 5



Batchen Model Mk III LPG Flowmeter and
Email Electronics Model VN Pulse Generator

10/1/20
10 December 2001

FIGURE 10/1/20 - 6



Solenoid Valve for Pre-setting Device

FIGURE 10/1/20 - 7

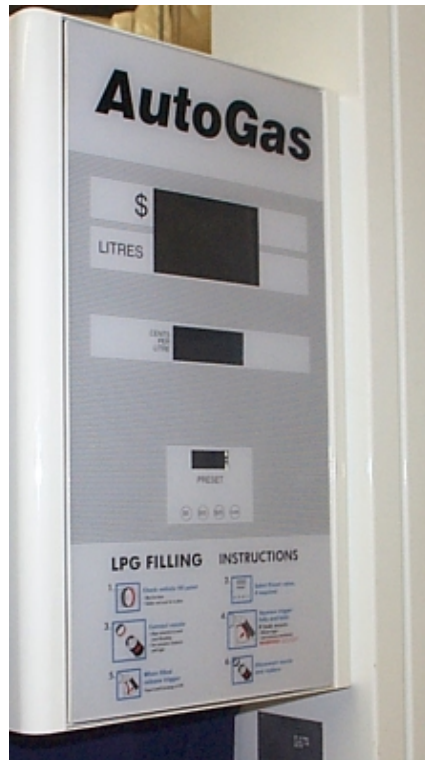

Calculator/Indicator With Pre-setting Device

10/1/20
10 December 2001

FIGURE 10/1/20 - 8



Typical CII Dispensers — Single (One Hose) Wardrobe Housing (CII-SWE-PA) and Dual Hose Cantilever Housing (CII-DCE-PA) Versions of the Pattern

FIGURE 10/1/20 - 9



Typical Quad (Four Hose) Housing

10/1/20
10 December 2001

FIGURE 10/1/20 - 10



Typical Twin Column Housing

FIGURE 10/1/20 - 11



Typical MPP Housing

10/1/20
10 December 2001

FIGURE 10/1/20 - 12

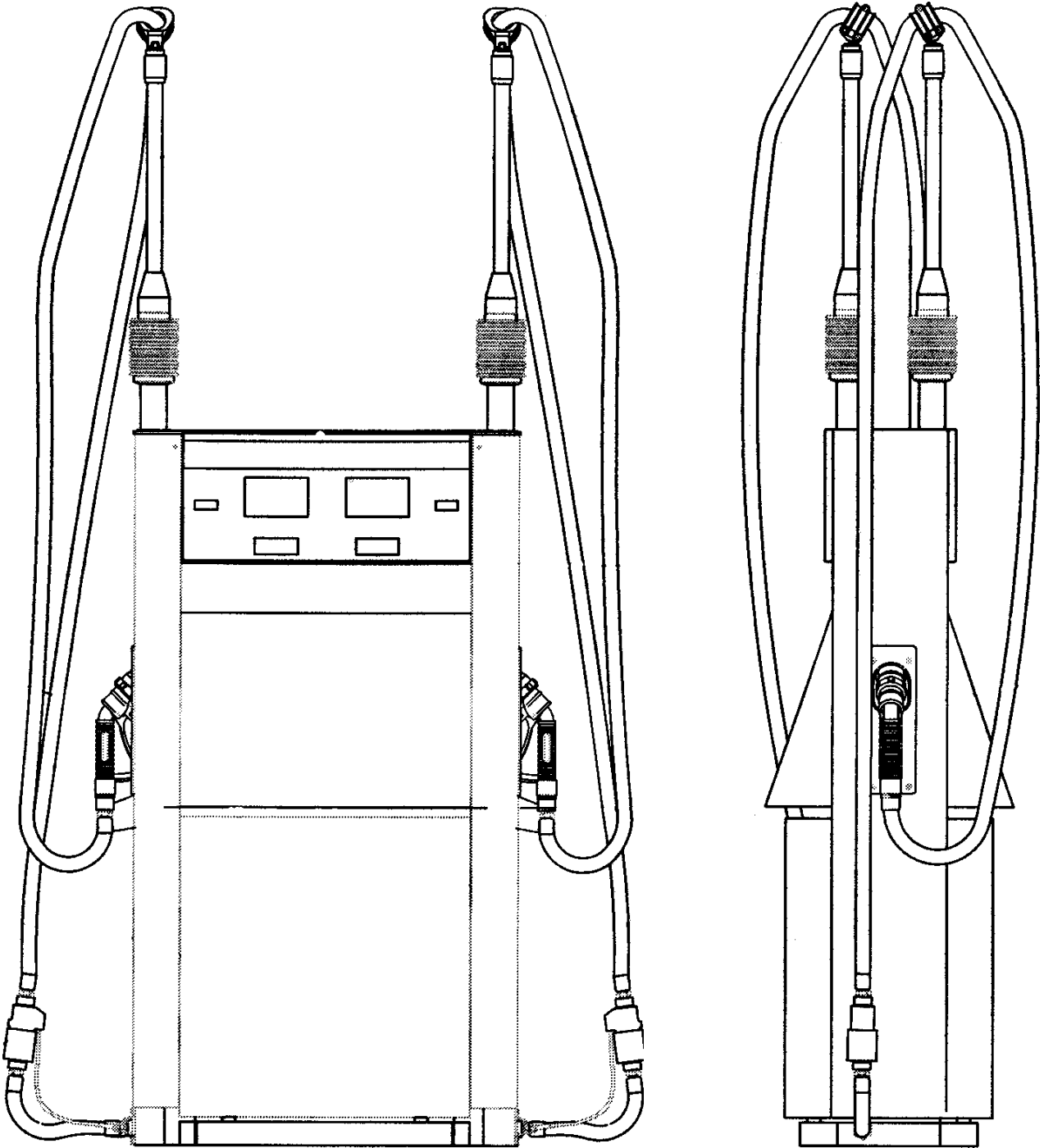

Typical End Oriented Housing

FIGURE 10/1/20 - 13

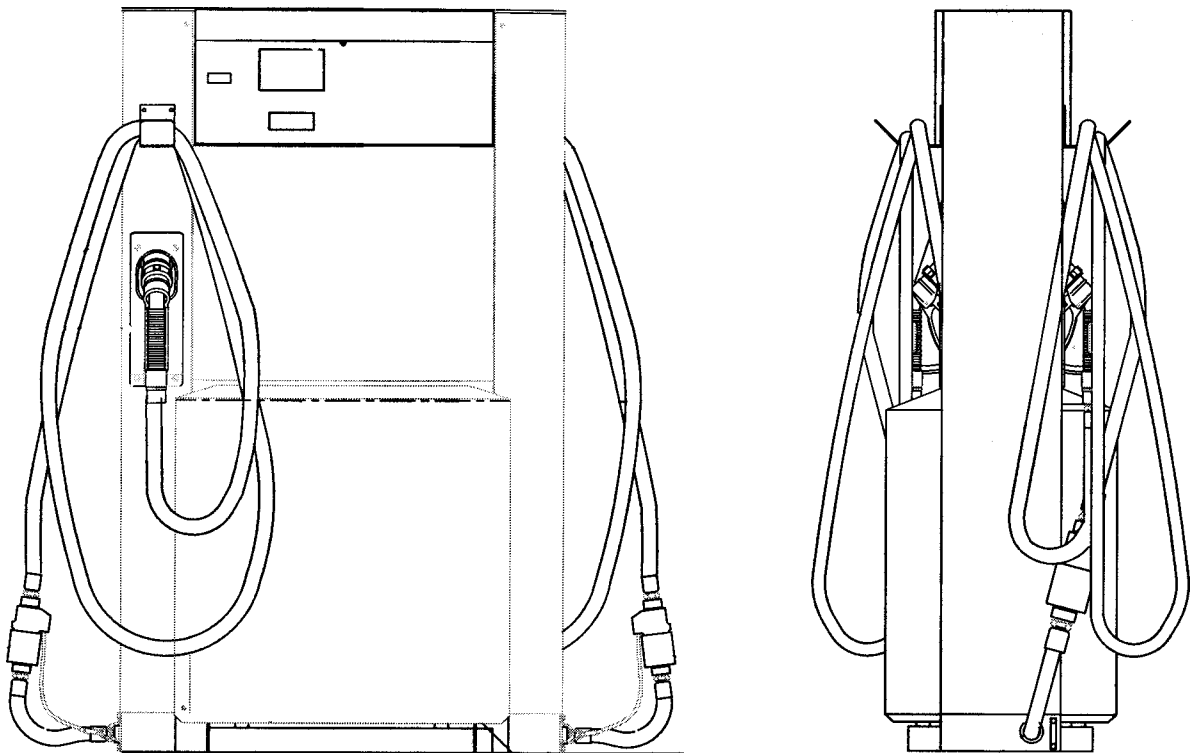

Typical Handed Twin Housing

10/1/20
10 December 2001

FIGURE 10/1/20 - 14



Showing Magnetic Coupling Between Meter
and Pulse Generator

FIGURE 10/1/20 - 15

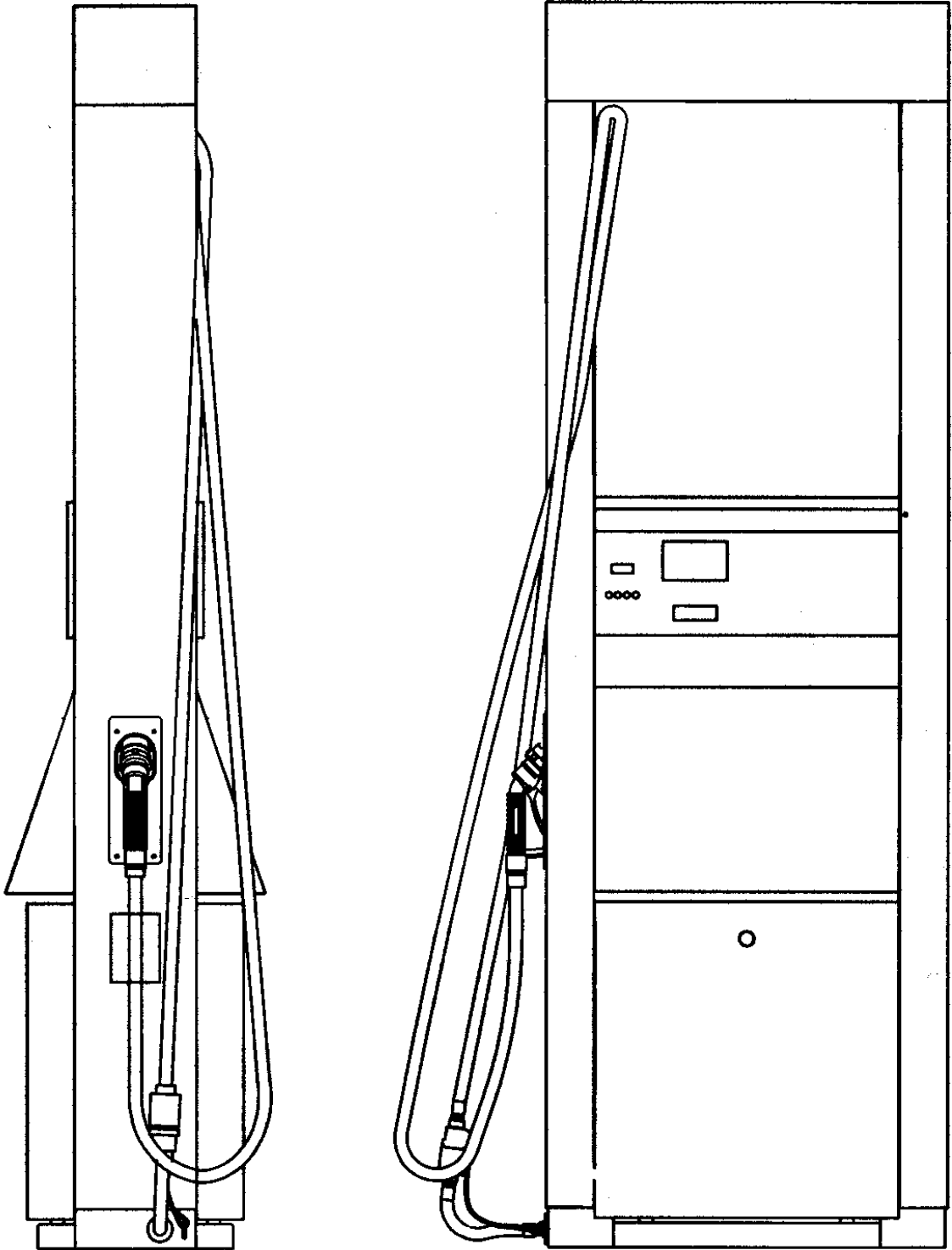

Batchen Model C11-SEE-PA Dispenser

10/1/20
16 September 2002

FIGURE 10/1/20 - 16

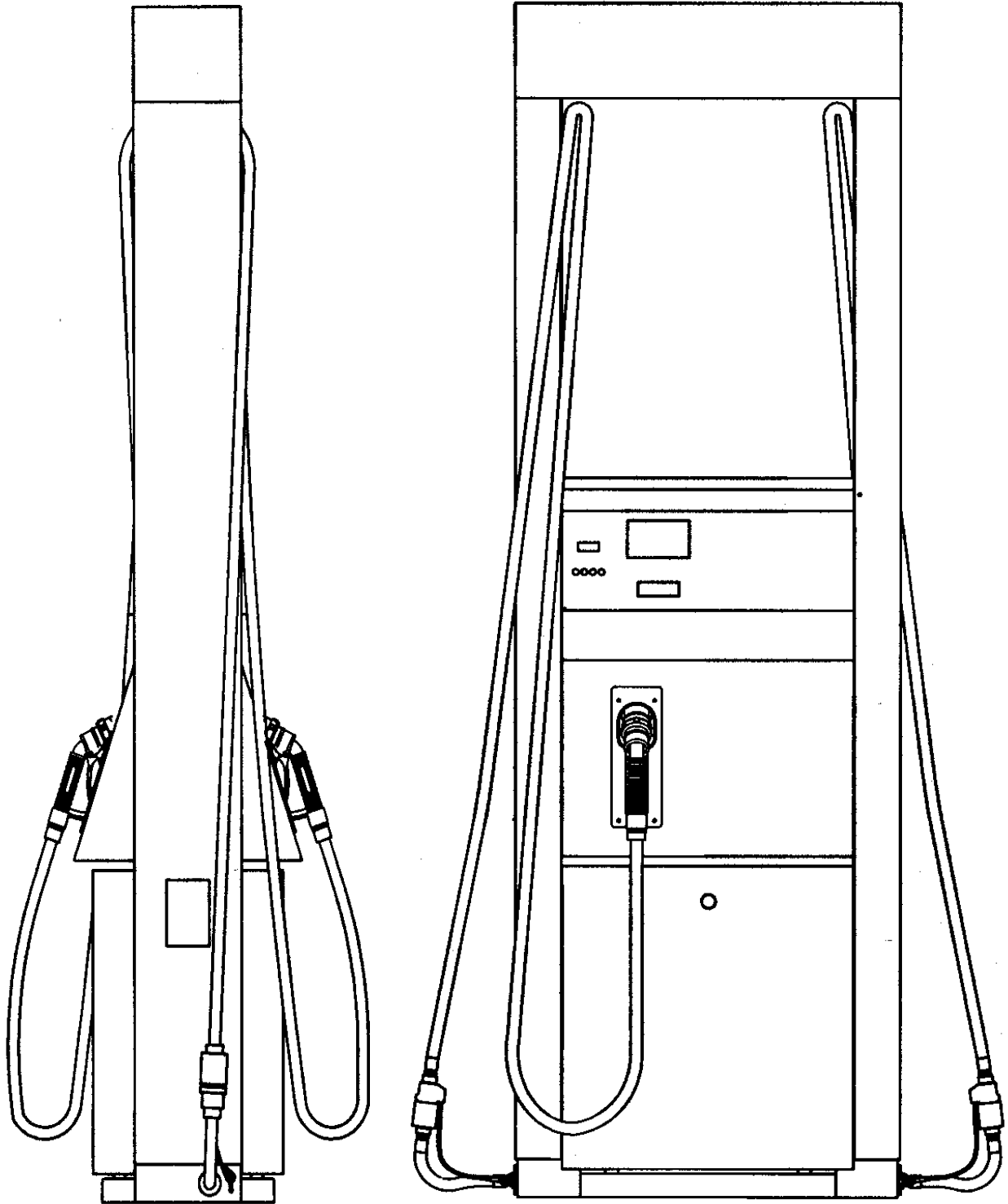

Batchen Model C11-DEE-PA Dispenser